

moveXX

driven by brain power



DATASHEET
Movexx T1500
2018



Specifications T1500

Frame	Steel, powder coated
Drive	24V DC, 600W, 100 rpm
Weight	105 kg
Weight trailer	1500 kg
Battery	Exchangable batterypack
Speed	Max. 4,7 km/h
Drive wheels	Full rubber ø250x80 mm
Width	483mm
Length	876mm
Adze height	750-1177mm (variable)
Folded	770mm
Noise level	68,5 dB
To use from	-40 °C / 70 °C
Protection class	Machine IP44

Dimensions T1500

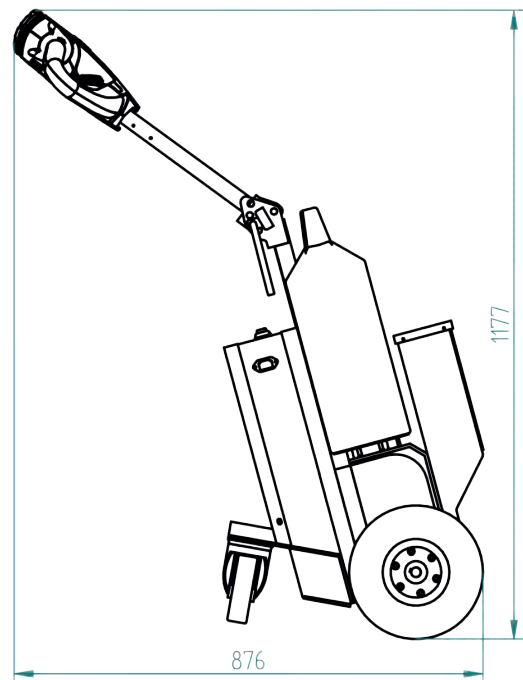
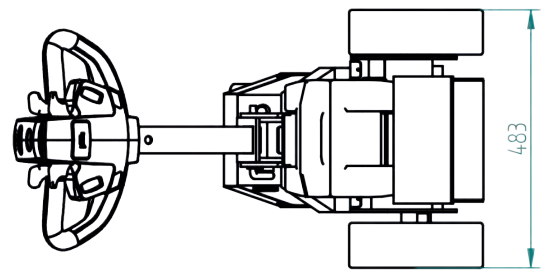

Pulling power T1500 (in kg)

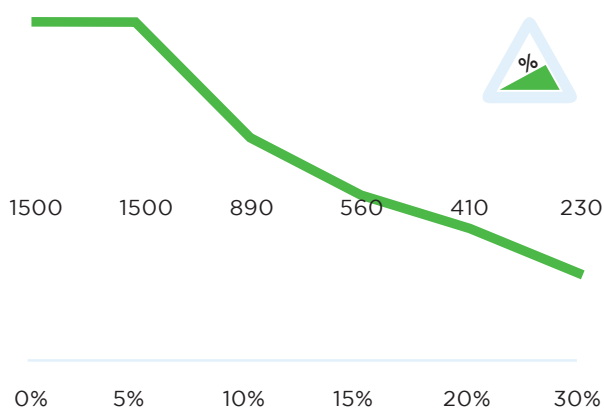

*Measured with a trolley with 2 swivelwheels and 2 fixed castors. Wheel diameter: 160mm

Standard T1500



Standard parts T1500

Charger 24V 5A incl. charging cable



Item number:
OPT0009

Batterie AGM 22Ah



Item number:
OPT110

Full-rubber drive wheel, black Ø250mm



Dimensions Ø250 x 80 mm

Item number:
M0248

Adjustable tillerhead



Item number:
Standardpart 1

Safety switch



Item number:
Standardpart 2

2 programmable speeds



Item number:
Standardpart 3

Standard parts T1500

Engine 600W 100RPM
BRAKE 6911413X



Item number:
M2098

LED battery indicator
LBF318-24V



Item number:
M0123

Options T1500



Extra plug to recharge the battery

for on-machine batterie charging

Article number:
OPT0001



Battery Lithium-LiFePO4,
36Ah GREEN

Article number:
OPT0106



Battery upgrade to Lithium-LiFePO4, 36Ah

iso AGM Battery (!) Including upgrade to lithium charger 10A

Article number:
OPT0107



Batterie AGM 22Ah

Article number:
OPT0110



Upgrade Nonmarking tires (2) yellow CR

Article number:
OPT0357



Upgrade Nonmarking tires (2) grey

Article number:
OPT0359



Upgrade Foam filled tires (2) black

Article number:
OPT0360



Upgrade Foamfilled tyres Nonm. (2) grey

Article number:
OPT0361



Emergency stop complete

Article number:
OPT0063



Strobelight

Article number:
OPT0065



Acoustic signal driving backwards

Article number:
OPT0254



Radio remote control

6 channel

Article number:
OPT0026-4

Options T1500



Document holder with clip

Article number:
OPT0053

hour counter complete



Article number:
OPT0056

Horn 90dB



Article number:
OPT0057

Antistatic strip



Article number:
OPT0058

Code lock



Article number:
OPT0068

Preparation electric hook



Article number:
OPT0143

Ignition key unequal key



Article number:
OPT0145

Ignition key equal key 701



Article number:
OPT0146

Customized programming



please indicate specific settings

Article number:
OPT0170

Programmer for Italsea



Article number:
D0003

Wall mounted Charger, for AGM battery



Complete charger-unit Including AGM battery charger (5 Ah)

Article number:
OPT0015

Charging Station for 1 Lithium battery



Wallmounting chargerstation with lithium battery charger 29,2 V, 10 A

Article number:
OPT0023

Options T1500



Charging station for 5
Lithium batteries

Article number:
OPT0029



Charging station for 5
batteries

*Upright standing charging
station with five separate AGM
battery chargers 24 V, 5 A*

Article number:
OPT0039



Attachment for trolley
(Caddie)

Article number:
OPT0040



Frame for 4-wheel waste
container

Article number:
OPT0085



U-Frame for waste container
1000/1100L

Article number:
OPT0088



Upgrade to charging
station

Article number:
OPT0261



Adaptor for Airport Trolleys

Article number:
OPT0325



Adaptor for shopping
trolleys on T1000

Article number:
OPT0326



Base part hook 15°

Article number:
H7010



Base part hook 15° double
spring

Article number:
H7020

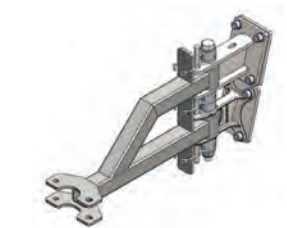

Base part heavy hook 15°
lowered

Article number:
H7050

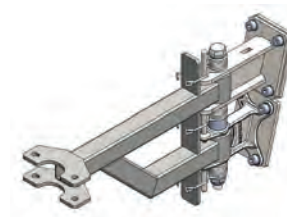

Base part heavy hook 15°
raised

Article number:
H7060

Options T1500

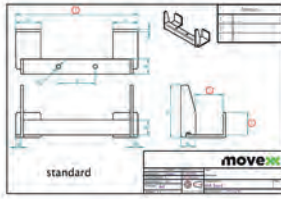

Customized Hook

Please complete corresponding sheet (!)

Article number:
HA5000

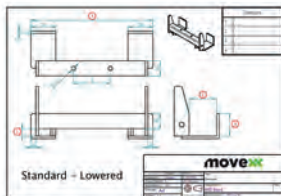

Customized Hook (LOWE-RED)

Please complete corresponding sheet (!)

Article number:
HB5000

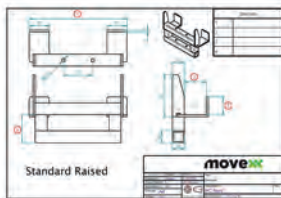

Customized Hook (RAI-SED)

Please complete corresponding sheet (!)

Article number:
HC5000

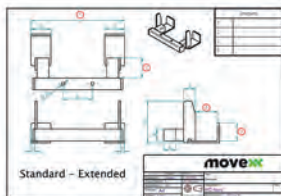

Customized Hook (EX-TENDED)

Please complete corresponding sheet

Article number:
HD5000

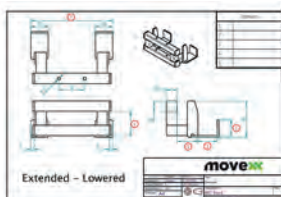

Customized Hook (EX-TENDED / LOWERED)

Please complete corresponding sheet

Article number:
HE5000

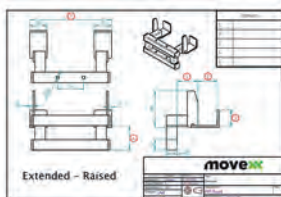

Customized Hook (EX-TENDED / RAISED)

Please complete corresponding sheet

Article number:
HF5000

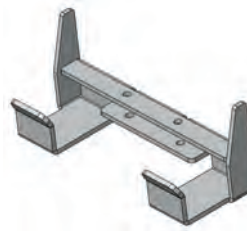

HA245.55.45.15.0

Fronthook for 50mm. Profile, Heavy Duty Hook

Article number:
H0004



hitch ball coupling Ø 50mm incl. adapter

Article number:
H0068



Hook for LKE Platformwagen Type X

Article number:
H0076

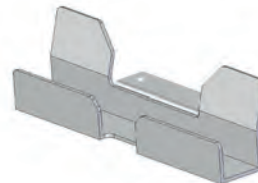

HA250.35.30.0.0

Hook for 30 mm. Profile For furniture trolley

Article number:
H0097



Hook locking system

Article number:
OPT0012



Electrical locking module for hook

Article number:
OPT0129

Options T1500



Electric lifting module
T1500

Article number:
OPT0279



Movexx Parking label

Article number:
OPT0245



HA270.43.40.0.0

Fronthook for 40mm. profile. Hartwall Pallet-Trolley (DOS1870)

Article number:
H0003



HA250.43.35.0.0

Front hook 40mm. profile

Article number:
H0051



HB245.43.30.5.0

Fronthook for 40mm. profile

Article number:
H0054



HD370.73.35.0.40

Fronthook for 70mm. profile (Flower container)

Article number:
H0055



HA245.142.35.0.0

Fronthook for 140mm. profile (wooden trolley)

Article number:
H0057



HA250.23.27.0.0

Fronthook for 20mm. profile

Article number:
H0067



Hook K-Hartwall dolly
DOS1617/1636, 25°

Article number:
H0086



HD245.10.35.0.50

Fronthook for Hatchery trolleys (EMKA)

Article number:
H0090



HB245.60.45.30.0

Fronthook for FEIL plastic floor trolley

Article number:
H0092



HA250.28.30.0.0

Fronthook for 25mm. profile

Article number:
H0094

Options T1500

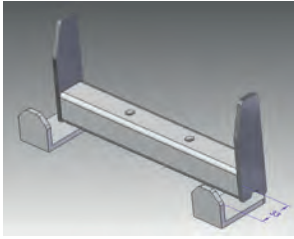

HA250.33.30.0.0

Fronthook for 30mm. profile

Article number:
H0095

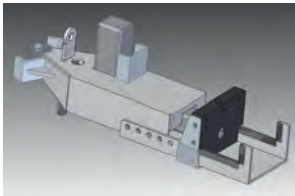

Clamping Hook Stainless steel

Article number:
H0096



HF242.23.30.15.20

*Fronthook for 20 mm. profile
(Hospital Logistics)*

Article number:
H0116

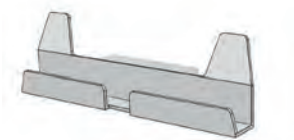

HA250.23.20.0.0

Hook for 20 mm. profile

Article number:
H0123



HB135.18.20.35.0

*Fronthook for 15mm. profiel
(Hartwall Dolly 400x600)*

Article number:
H0125



Coupling nettingscontainer,

Nettings 6mm

Article number:
K0007



Coupling rollcontainer

Nettings 10mm.

Article number:
K0008



Coupling Rollcontainer

Width 42 mm.

Article number:
K0010



Coupling Rollcontainer

Suitable for rack Ø6 mm. (Deli XL)

Article number:
K0012



Coupling with carabiners

Article number:
K0026

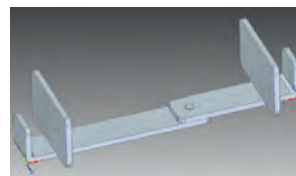

Coupling jaw 20mm

Article number:
K0027



Coupling trolleys side R28

Article number:
K0028

Options T1500



Coupling Open Front-Closed Backside

Article number:
K0030

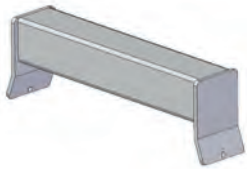

Welding part for trolley's

Profile 50x50mm.

Article number:
OPT0032



Bolt-on part for Trolley's

Profile 50x50mm.

Article number:
OPT0033



Angle limitation hook 15 degrees

Article number:
OPT0218



Protective elec connection T1000

Article number:
OPT0263

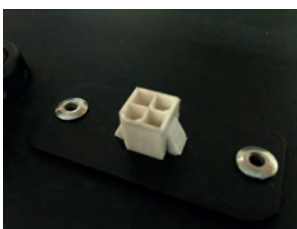

Diagnostic connector

Article number:
OPT0270

Lifting module and clamping hook T1500



Article number:
OPT0386

Urgent order surcharge



Article number:
SPOED



Movexx International B.V.

Generatorstraat 17

3903 LH Veenendaal

Tel +31 (0)318 51.99.00

Fax +31 (0)318 50.80.20

E-mail info@movexx.nl